



CARING
FOR DETAILS

D'tail
By ISTOBAL

D'tail
by **ISTOBAL**

MAKES THE DIFFERENCE

Cleaning your vehicle's surface is not enough for a perfect finish. For an exceptional finish, some details do make a huge difference. For that reason, ISTOBAL offers you a wide range of accessories designed to meet your every need, from the professional cleaning of the interior to the perfect tyre pumping, ensuring complete care and maintenance.





ISTOBAL

cleaning

ISTOBAL

wash

Models 4AA10 / 4AA20

General features

- > Robust
- > Reliable
- > Low maintenance

Main features

- > Colour-customisable cover
- > Structure in AISI 304 stainless steel or painted in the colour of your choice
- > Wide range of payment systems: coins, tokens, proximity cards, combined method
- > External display with time and service counter
- > 4 polyester filter sleeves with external or automatic filter shaker
- > 5 or 10 m suction hose
- > IW Manager software for integrated control

Technical features:

- > Turbine-type motor, 1.1 kW (single phase), 1.75 kW and 2.2 kW
- > Maximum suction: 3.000 mm H₂O
- > Maximum flow rate: 330 m³/h
- > Filtering surface: 4 x 2,600 cm² = 10,400 cm²
- > Tank capacity: 36L

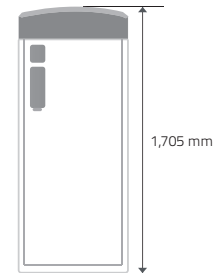
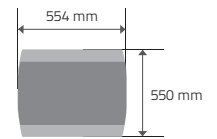

◀ **Model 4AA10**



Turbine detail

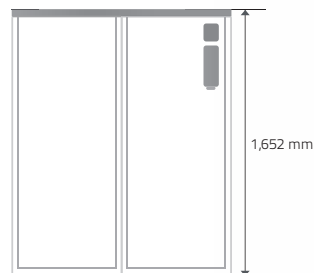
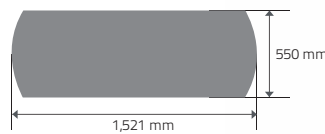

Model 4AA20 ▶



Turbine detail



VACUUMS



Model 4AA00

General features

- > Simple
- > Effective
- > Functional

Main features

- > AISI 304 stainless steel structure
- > 2 polyester filter sleeves with internal filter shaker
- > Token or coin basic payment system
- > Service counter
- > 5 or 10 m suction hose

Technical features:

- > 2 by-pass motors, 1 kW (230V)
- > Maximum suction: 2.200 mm H₂O
- > Maximum flow rate: 400 m³/h
- > Filtering surface: 2 x 2,600 cm² = 5,200 cm²
- > Tank capacity: 27 L

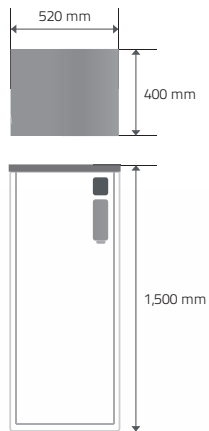

Model 4AA00 ▶



Motor detail

MORE OPTIONS

PAYMENT SYSTEMS

Three alternative payment systems: mechanical or electronic coin validator and proximity cards. All three include an external display indicating the service time remaining. Anti-vandal protection can be incorporated as an optional extra.



BLOWER OR FRAGRANCE

With an air blower to reach the smallest corners or with a nice fragrance.

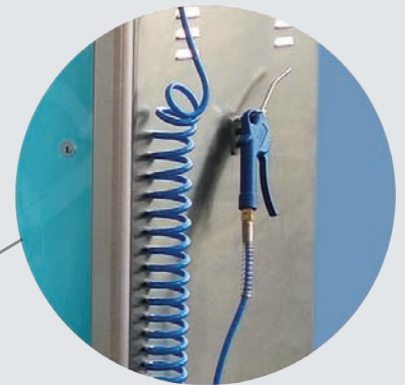
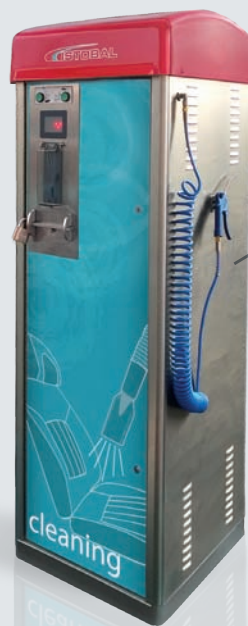

IW MANAGER

New software designed for total remote and local management of all the units in your wash facility.



SPRING HOLDER

The functional layout of the spring facilitates the use of the vacuum hose, preventing it from hanging on the ground and avoiding nozzle damage.



Model 4QA00

General features

- > Simple
- > Functional
- > Versatile

Main features

- > AISI 304 stainless steel structure
- > Product selector
- > External viewer with countdown timer and service counter internal function
- > Decorative vinyl included
- > Two or four products

Configurations:

- > **Exterior prewash**
Flat nozzle for insect remover and rim degreaser products.
- > **Interior care**
Spray nozzle for fragrances, and dashboard and tyre polish.

Technical features:

- > Power: 2x55W or 4x55W
- > Flow rate: 0.22 L/min prewash or 0.08 L/min spraying
- > Capacity: 2 x 20 L / 4 x 10 L
- > Hose length: 3.5 m without boom arm / 8 m with boom arm
- > Voltage: 230 V

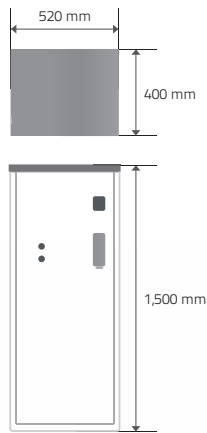

Model 4QA00 ▶

OPTIONS

- > Payment systems: token, mechanical or electronic
- > Boom arm
- > Internal heater
- > Products 



Spraying detail

2 POSSIBLE CONFIGURATIONS

EXTERIOR PREWASH OR INTERIOR CARE

SPRAYER



Analogue Model 4VA01

General features

- > Accurate
- > User-friendly
- > Design

Features:

- > Stainless steel structure. AISI 304
- > Easy-to-read, accurate pressure indicator. Compliant with EC directives
- > Air only, or air and water
- > Air and water automatic hose reels or spiral hoses
- > Reinforced inflater adaptor

Technical features:

- > Pressure: 0-10 bar/ 0-145 psi
- > Reading: 0.1 bar/2 psi
- > Hose length: 8 m (hose reels) or 7.5 m (spiral hoses)

Digital Model 4VA11

General features

- > Precision
- > Reliability
- > Simplicity

Features:

- > Stainless steel structure. AISI 304
- > Clear and precise digital LCD pressure display. Compliant with EC directives
- > Sounder goes off when the set pressure is reached
- > Air and water automatic hose reels
- > Payment systems: coins, tokens, proximity cards, combined method
- > Dual-nozzle inflater adaptor

Technical features:

- > Power supply voltage: 230 V
- > Pressure: 0.3-10 bar/ 4-145 psi
- > Reading accuracy: <0.08 bar/ <1.16 psi
- > Hose length: 8 m

OPTIONS

- > Payment system is optional

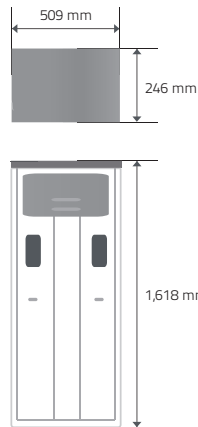

Model 4VA01 ▶

Benefits of having the right tyre pressure:

- + SAFETY
- WEAR
- FUEL CONSUMPTION



OPTIONS

- > Possibility of including internal compressor, direct type or with tank.

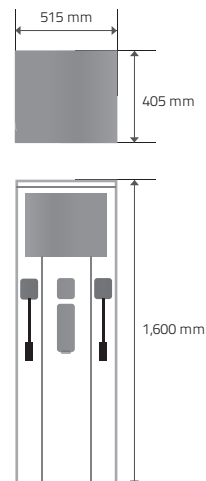

◀ Model 4VA11

TYRE PUMPS AND GAUGES



COMBO

General features

- > Compact
- > Versatile
- > Practical

Features:

- > Stainless steel structure. AISI 304
- > LED display with countdown timer; two possible configurations depending on function chosen
- > Function can be easily changed

> Vacuum

Turbine and filtering system with high suction power and low noise level

> Sprayer

Fragrances, dashboard, tyre polish, etc.
Possibility of including up to 4 different products for the final cleaning of your vehicle.

> Gauge

Air: Easy-to-use digital gauge with hose reel.
Possibility of including an internal compressor.

- > **Screen washer:** Hose with reel with water or washer fluid service.

ALL IN ONE,
THE PERFECT
COMBINATION OF
CLEANLINESS AND
SAFETY

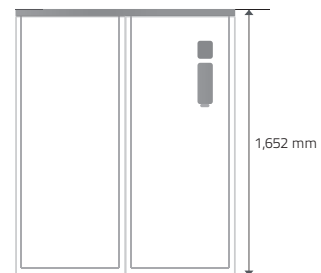
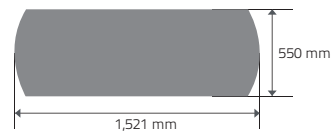

- > Do those little but important safety check-ups **while you vacuum** and clean your vehicle, like **pumping up the tyres** or **filling up the screen wash tank**.



Model 4KA00

VACUUM,
SPRAYER AND GAUGE,
ALL IN ONE

Vacuum



Sprayer



Gauge



Model 4LA00

General features

- > Design
- > Effective
- > Functional

Features:

- > AISI 304 stainless steel structure
- > Semi-automatic, cleans the dirtiest mat areas
- > Wash/dry selector
- > Can clean up to 80cm wide mats
- > Payment system: coins or tokens
- > Service counter

Technical features:

- > Blower: 1 kW
- > Usable brush width: 80 cm
- > Voltage: 380V

Model 4LA11

General features

- > Automatic
- > Clean
- > Robust

Features:

- > Automatic conveyor system with self-cleaning cycle
- > 2 rollers for brushing and 2 special rollers for drying
- > Dry or wet (water) clean selector
- > Indicator with time and service counter

Technical features:

- > Usable brush width: 54 cm
- > Voltage: 380V

OPTIONS

- > A bacteria disinfectant can be added. Heater is optional

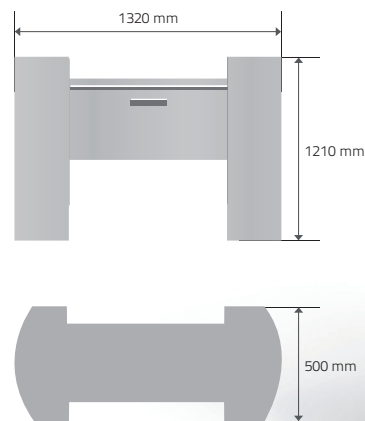

Model 4LA00 ▶



OPTIONS

- > A bacteria disinfectant can be added

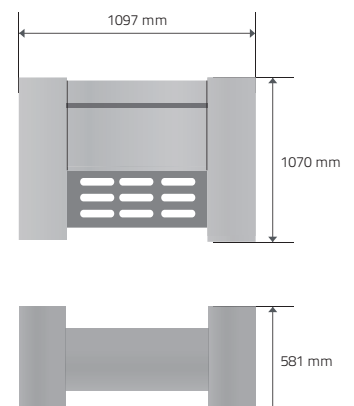

MAT CLEANER



Dryer Model 4SA00

Features:

- > Stainless steel structure AISI 304
- > Ergonomic drying nozzle
- > Service counter
- > Ø 50 mm coupling and hose

Configurations:

- > Standalone at self-service
- > Built-in in Modulbox
- > Built-in in enclosure

Technical features:

- > Power: 2x1.45 kW
- > Flow rate: 355 m³/h
- > Voltage: 230 V



Nozzle detail

OPTIONS

- > Wall or post-mounted boom arm
- > Token or coin operated mechanical payment system or via connection to main payment terminal
- > Extended length for additional hose
- > Decorative vinyl

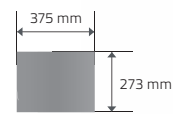

Model 4SA00 ▶



Paper/cloth dispenser Model 4XA00

Features:

- > AISI 304 stainless steel structure
- > No paper light indicator
- > Service counter

Configurations:

- > Paper or cloth
- > Paper or cloth with product

Technical features:

- > Power: 80 W or 150 W
- > Maximum roll width: 390 mm
- > Voltage: 230 V



OPTIONS

- > Mechanical or electronic token payment system
- > Decorative vinyl

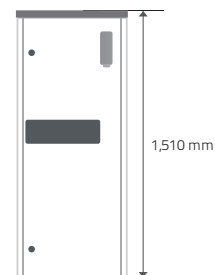
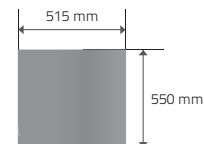

◀ Model 4XA00

OPTIONAL EXTRAS

Mat beater Model 4049100

Features:

Galvanised steel grate with rust protection, and 60 litre dust box with lock.



Mat beater Model 4049000

Features:

Curved tube, 60 mm hotdip galvanised steel for rust protection.



MORE OPTIONS



> Sound and heat insulation



> Inflator adaptor



> Heater



> Compressors

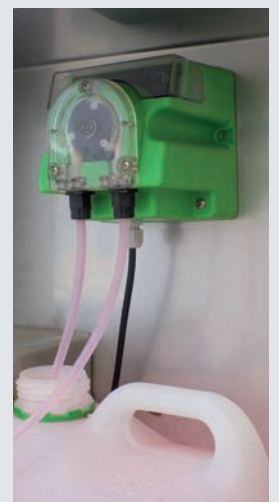

> Product dosing

Note: ISTOBAL, S.A. reserves the right to introduce whatever modifications it deems necessary.





lavado

sacudidor alfombrillas

sacudidor alfombrillas

cleaning

cleaning

Accessories

V. 05/2015

6CVAB10



ISTOBAL, S.A.

Conde del Serrallo, 10

46250 L'Alcúdia (Valencia) Spain

T +34 962997940 • F +34 962997991

istobal@istobal.com • www.istobal.com

